





# RHF-Active 400-480-50/60-20-A

## Product Features

- 
**Real-Time Harmonic Filtering:** Instantly detects and neutralizes harmonics across multiple frequencies, ensuring a clean power supply.
- 
**Compact Design:** Space-saving design allows easy integration into existing systems without compromising performance.
- 
**Modular and Scalable:** Easily scalable to suit different power requirements, from small installations to large industrial applications.
- 
**Optional Remote Monitoring Capability:** Available as an added feature if a custom control panel is built. Enables proactive maintenance and performance tracking, allowing users to monitor system health remotely.



Marine



Oil & Gas



Water Treatment



General Industry













Data Center



## Product Description

Active harmonic filter for reduction of the harmonic distortion of variable frequency drives or other non linear loads. SiC-Power MOSFET's and Schottky Diodes allows for very high efficiency and also enables switching frequency of 50kHz, which results in efficient elimination of harmonics. This filter reduces the THD of the current from typically 35% to below 5%.

## Key Benefits

-  **Energy Savings:** Actively reduces power losses caused by harmonics, leading to noticeable energy savings and a lower electricity bill over time.
-  **Extended Equipment Lifespan:** Reduces wear and tear on connected equipment by mitigating harmful harmonics, extending the service life of your electrical assets.
-  **Enhanced Power Quality:** Effectively reduces harmonic distortion, improving overall power quality and minimizing electrical interference.
-  **Compliant with Industry Standards:** Meets global harmonic compliance standards, providing peace of mind and simplifying regulatory compliance.
-  **Energy Efficiency:** Helps optimize energy consumption by minimizing power losses, leading to cost savings over time.
-  **Reduced Downtime:** By preventing harmonic-related issues, the filter reduces unexpected equipment failures and minimizes maintenance needs, improving system uptime.
-  **Reliable Performance:** Designed for continuous operation, ensuring stable performance even under varying load conditions.
-  **Environmentally Friendly:** Lowers energy consumption and reduces greenhouse gas emissions, supporting sustainable operations.
-  **Enhanced Safety:** Decreases the risk of overheating and electrical faults caused by harmonics, promoting a safer work environment.
-  **Increased Power Capacity:** Improves power factor and optimizes current flow, allowing existing power infrastructure to support more load without additional investments.



### General Specification

Type Code	RHF-Active 400-480-50/60-20-A
Order Code	35000067
Rated Current	400A (Compensation Current)
Rated Voltage	220-480V (+10% / -10%)
Rated Frequency	50/60Hz (+/-2%)
Parallel Quantities	1 x 100A & 2 x 150A
CT Accuracy	0.5 or Better Accuracy
CT-locations	Grid or Load side (Close-Loop or Open-Loop)
Number of CTs	2 • for 3P3W system & 3 • for 3P4W system
Topology	SiC - Power MOSFET's and Schottky Diodes
Function	Power Factor Correction Imbalance Compensation Harmonic Mitigation
Harmonics Filtering Range	Harmonic Mitigation Of Harmonics 2nd to 61st Order
Reaction Time	10 ms
Response Time	20 ms
Target Power Factor	1-LD or LG (Leading or Lagging)
Switching Frequency	30 kHz - 50 kHz
Cooling method	Internal Fans
Redundancy	Unlimited (A single filter can run on its own regardless if the other filters have failed)
Load Balancing Capacity	Rated Capacity
Power Loss	5523W
Typical Motor Rate	850kW (For 35% compensation ratio target 5%)
Efficiency	>98%
Sys. Efficiency	>99.3% (for 850kw drive rating)
Transport Temperature	-10 °C to +65 °C
Storage Temperature	-10 °C to +55 °C

### Electrical connections, controls, and auxiliary supply

Main Supply Terminals	Barrier Terminal, Screw Connection M8, 10-70mm <sup>2</sup> (8-3/0AWG) Tightening Torque, Min-Max.: 3.5-8.0Nm
Network	3P3W (220-480V) 3P4W (220-415V)
Communication Ports	RS485
Communication Protocols	Modbus by RTU Configuration Software
Protection Function	Overvoltage / Overcurrent / Overload / Overtemperature / Resonance / DC Bus Overvoltage / Abnormal Frequency

### Mechanical Properties

Mounting Type	Wall mount/ rack mount/ cabinet
Dimension (W x D x H) mm	97*482.5*722
Weight	1 x 31kg & 2 x 33kg
Colour	White

### Environment Requirement

Altitude	<2000m, Derating 10%/1000m, Max 4000m
Ambient Temperature	°C / Max ambient temperature with derating 55°C ≥ Td' > 50°C, (Capacity) : 80%; 50°C ≥ Td' > 45°C, (Capacity) : 90%; 45°C ≥ Td' > 40°C, (Capacity) : 95%; 40°C ≥ Td', (Capacity) : 100%;
Humidity	5...95% - (Non-condensing) During Operation
Deg of protection	IP20

### Standard & Requirement

Standard Compliance	IEC/EN61000-2-2/ -4 IEC/EN61000-2-2/ -4 / -12 IEEE 519-2022 ER G5/4 EN 62477-1:2012+A11:2014+A1:2017 EN 60529:1991+A2:2013+AC:2019-02 EN 61800-5-1:2007+A1:2017 UL 508 & CAN/CSA C22.2 No. 14-18 - Standard for Industrial Control Equipment
---------------------	--



**Working principle RHF-Active**

Active Harmonic Filters are parallel filter circuits injecting harmonics into the supply. These Harmonics have phase shift of 180° compared to the harmonics in the system. Therefore the injected Harmonics are eliminating the Harmonics seen from the mains supply. The following picture helps to verify the principle.

The REVCON RHF-Active, do not require any expensive commissioning on site. After power up, the unit will do self commissioning in order to reach the best possible performance, but of course individual settings are also possible. Beside harmonic mitigation of harmonics from the 2nd to 61st order, the RHF-Active offer compensation functions such as power factor correction and imbalance compensation.

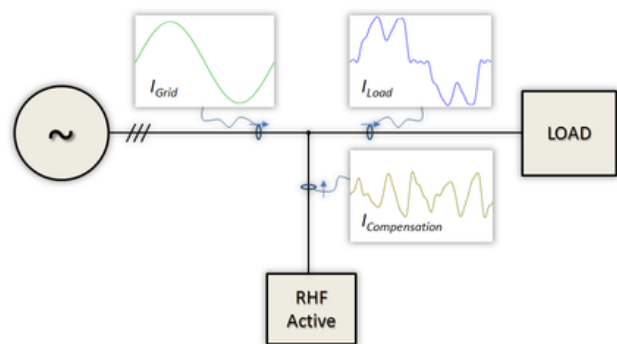

Physical dimensions filter RHF-Active 100-480-50/60-20-A

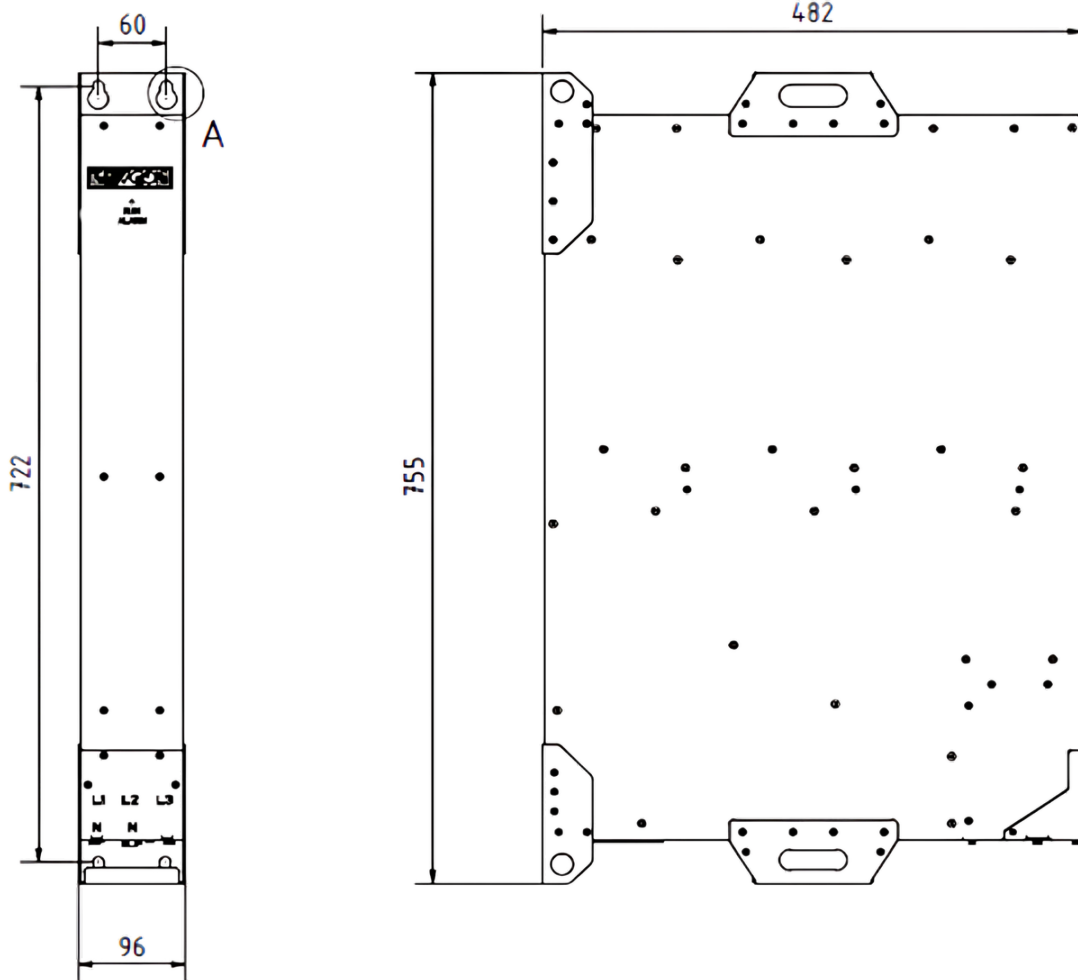

A ( 0,40 : 1 )

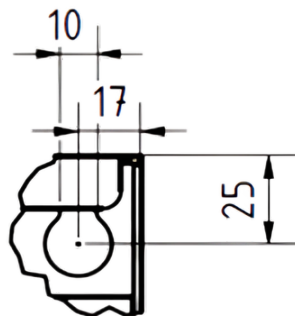

Physical dimensions filter RHF-Active 150-480-50/60-20-A

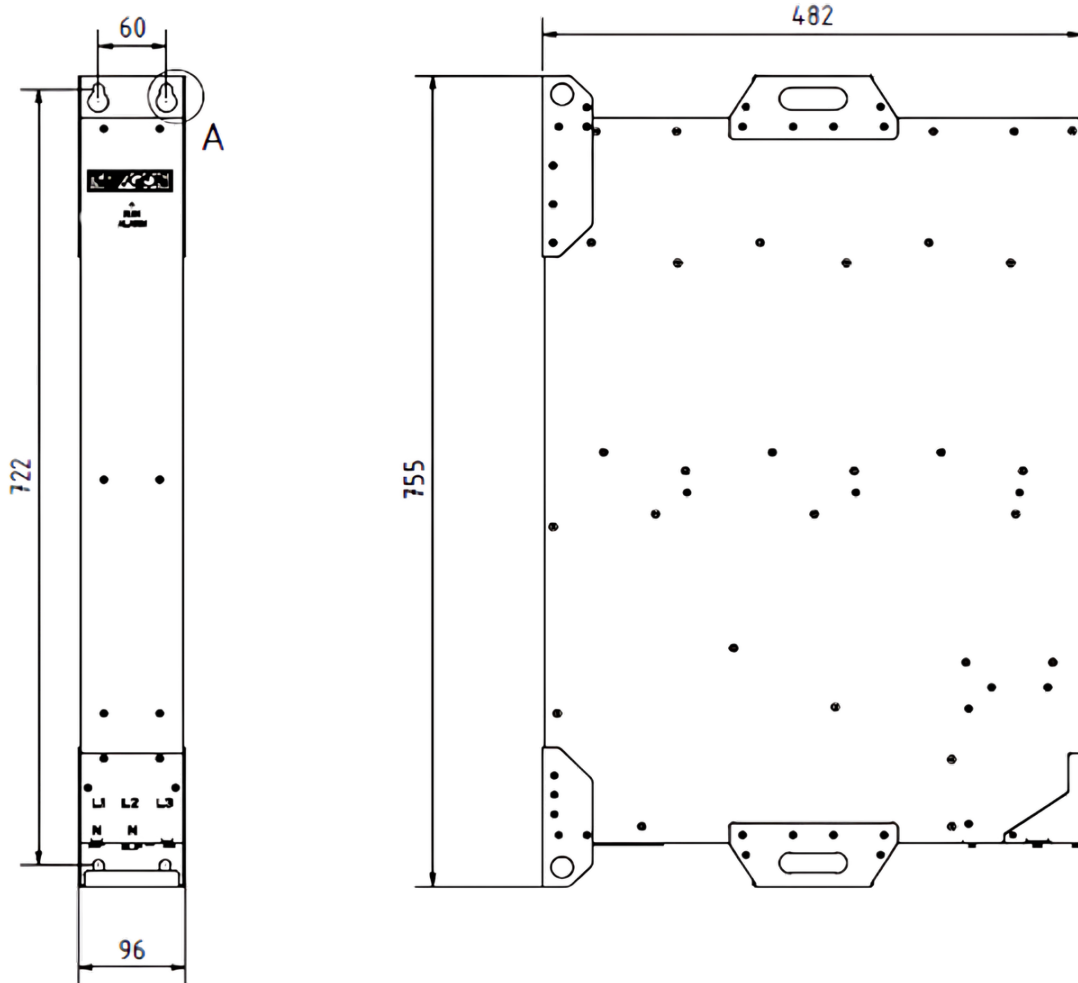

A ( 0,40 : 1 )

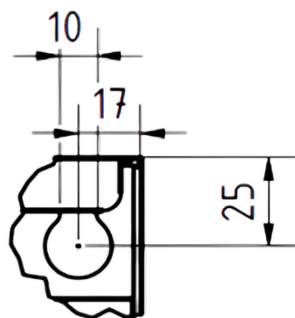

Wiring Principle 3P3W

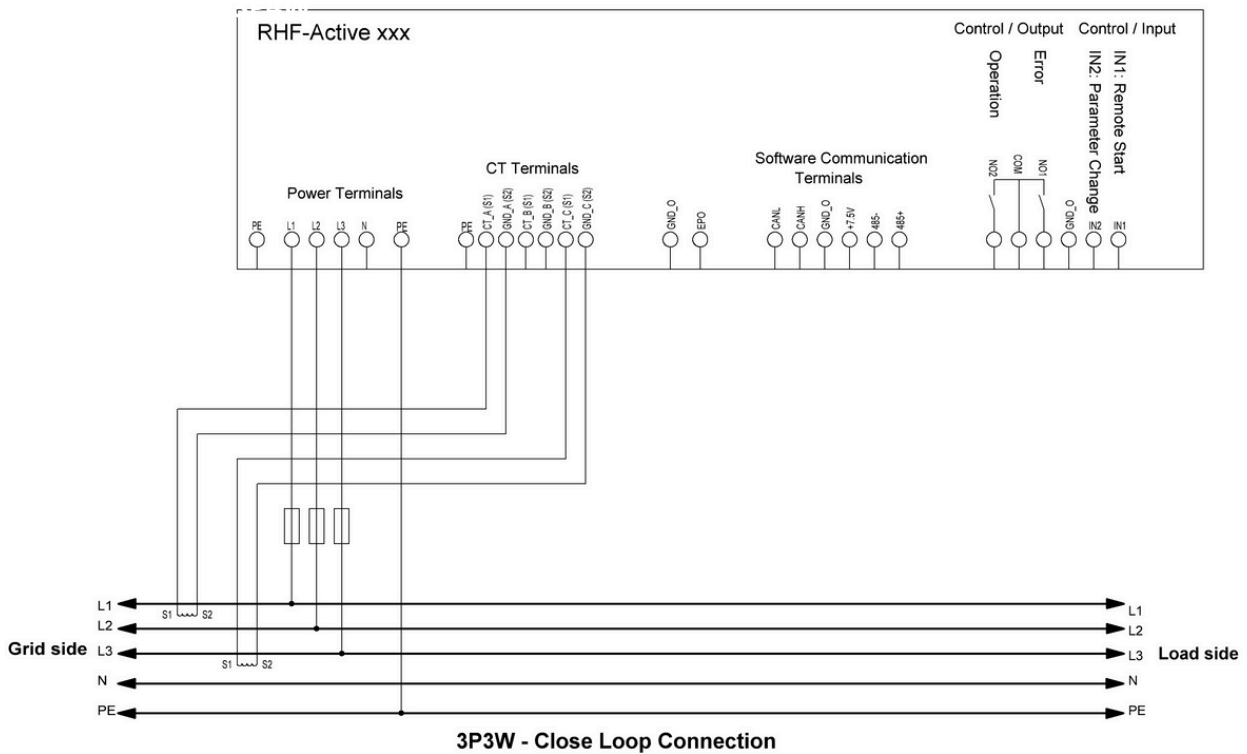
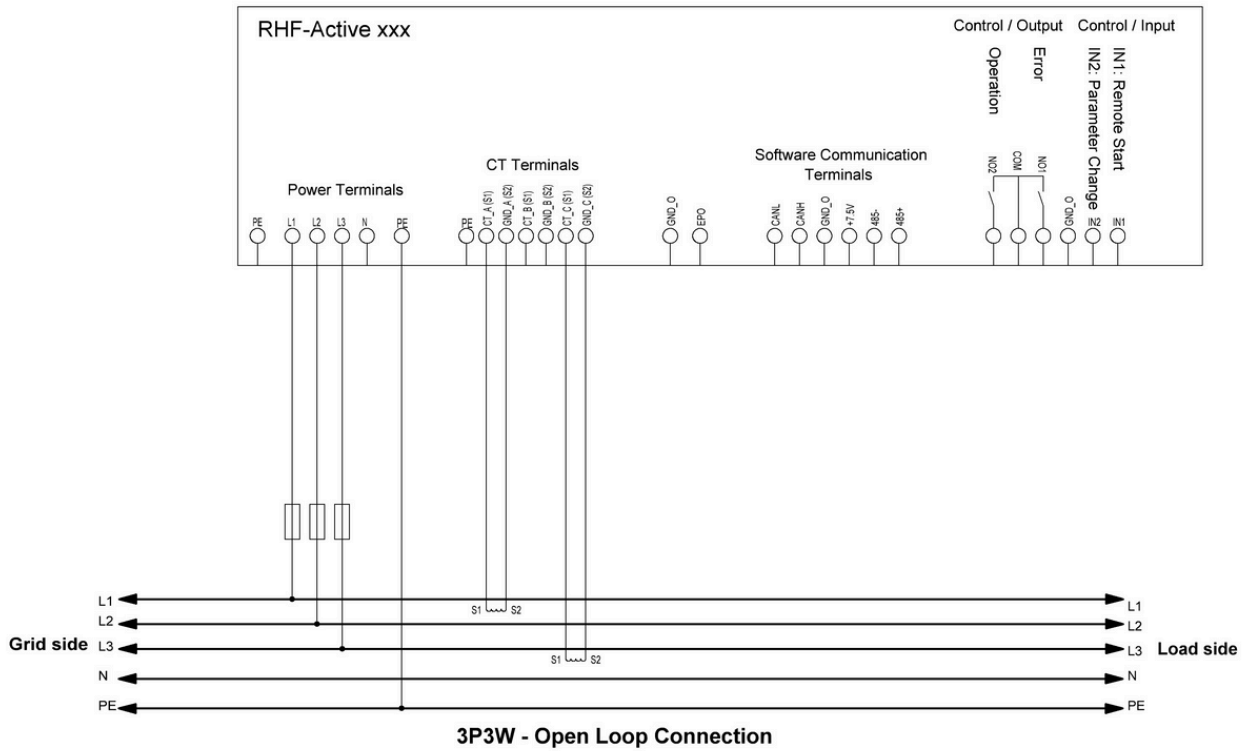



Wiring Principle 3P4W

