

Uninterrupted Power Supply

COVER CORE

1-3 kVA

User manual



THE POWER IS ON

The content of this document is the copyright of the publisher and it may not be reproduced without permission.
We reserve the right to modify the design and specifications without prior notice.

©Copyright 2016
COMEX S.A.
All rights reserved.

Table of contents

1.	Safety rules.....	1
2.	Transport, unpacking UPS.....	2
2.1.	Rack 19'' Installation.....	3
2.2.	Tower Installation	3
3.	Design and connection.....	4
3.1.	Rear panel view	4
3.2.	Internal batteries connection.....	5
3.3.	External batteries connection	5
3.4.	Power connection	6
3.5.	Load connection	6
3.6.	Remote EPO connection	6
3.7.	Communications connection	7
3.8.	TVSS connection.....	7
4.	Operations of LCD	8
4.1.	Funcktion keys.....	8
4.2.	LCD Screen.....	8
4.3.	Audible alarms.....	10
4.4.	Letter abbreviations LCD	10
4.5.	Menu UPS.....	11
4.6.	Description of UPS modes.....	13
4.7.	Error codes	14
4.8.	Warnings UPS and audible alarms	15
5.	Operation of UPS	16
5.1.	Turn UPS.....	16
5.2.	Turn off UPS	16
5.3.	Battery test.....	16
5.4.	Mute audible alarm.....	16
5.5.	Software installation	16
6.	Operating environment and operation of the UPS.....	17
6.1.	Operating conditions.....	17
6.2.	Storage conditions.....	17
6.3.	Battery replacement	17

1. Safety rules

This manual contains information on the safe use of the UPS. Before unpacking and installing the power supply, please read it carefully and follow its recommendations.

	Meets the standards - EXECUTION
EN 62040-3	Uninterruptible power systems (UPS): The methods for determining the properties and test requirements.

	Meets the standards - Electromagnetic compatibility
EN 62040-2 :2006 C2	Uninterruptible Power Supply (UPS): Electromagnetic compatibility.
EN 61000-2-2 :2002	Electromagnetic compatibility (EMC): Environment. Compatibility levels for disturbances Conducted LF and signaling in public low-voltage power systems.
EN 61000-4-2 :2009	Electromagnetic compatibility (EMC): Testing and measurement - test of resistance to electrostatic discharge.
EN 61000-4-3 :2006 +A2 :2010	Electromagnetic compatibility (EMC): Testing and measurement techniques - Test of resistance to electromagnetic field of radio frequency.
EN 61000-4-4 :2012	Electromagnetic compatibility (EMC): Testing and measurement techniques - Test of resistance to fast transients.
EN 61000-4-5 :2014	Electromagnetic compatibility (EMC): Testing and measurement techniques - Surge immunity test.
EN 61000-4-6 :2014	Electromagnetic compatibility (EMC): Testing and measurement techniques - Immunity to conducted disturbances, induced by radio-frequency fields.
EN 61000-4-8 :2010	Electromagnetic compatibility (EMC): Testing and measurement techniques - field immunity test frequency magnetic grid.
The device complies with Directive 2004/108/EC (EMC).	

	Meets the standards - SAFETY
EN 62040-1 :2008	Uninterruptible power systems (UPS): General and safety requirements for UPS.
EN 60950-1:2006	Equipment of teleinformation. Security.
IEC 60417	Symbols used on devices
The device complies with Directive 2006/95/EC (LVD).	

- Keep this user manual! It contains important information regarding the operations of UPS which should be used during installation and maintenance of the UPS and batteries.
- If the power supply is cold and will be moved to a warm room, condensation may occur. Therefore, you should wait at least 2 hours until its launch.
- To reduce the risk of electric shock, the UPS should be installed in a room free of contaminants at the right temperature and humidity. The ambient temperature must not exceed 40°C.
- Do not connect to the UPS output devices, which can cause it to overload, eg. Laser printers, electric heaters, etc..
- Cables should be connected and positioned in such a way that no one has the possibility of accidentally occur, or disconnected.
- The UPS must be connected to the wall socket with the proper protective conductor (PE).
- Do not block ventilation openings in the UPS. Make sure that the ventilation holes are discovered and there is a minimum of 25cm of free space for free ventilation.
- Power supply socket UPS should be protected by an appropriate switch or circuit breaker.
- The UPS has its own power source of the battery, so sockets output voltage may be present, although the UPS is not connected to the network.
- Support the battery should be performed by trained personnel who are knowledgeable about the battery life and retain appropriate precautions during their use.
- When replacing the batteries, use batteries of the same amount and with the same parameters, ie. Nominal voltage, capacity and dimensions.

WARNING! Do not dispose of batteries in a fire. The battery may explode.

WARNING! Do not open or damage batteries. Released electrolyte is harmful to skin and eyes. It may be toxic.

- A battery can present a risk of electric shock. When working with batteries, take the following precautions:
 - Remove from the hand of watches, rings and other metal objects.
 - Wear rubber gloves and boots.
 - Do not lay tools or metal parts on the battery.
 - Disconnect the source for charging the battery before connecting or disconnecting battery terminals.
- Make sure the battery is not accidentally grounded. If present, remove the source of ground fault. Contact with any part of a grounded battery can result in electrical shock.

2. Transport, unpacking UPS

Check carefully that the carton and the contents are not damaged. If any damage is found, immediately notify the shipping company and distributor of power supply. Do not dispose carton of UPS.

1. If there was not any damage carefully open the carton.
2. Extract all the protective elements (sponges, fillers).
3. Gently remove the UPS from the protective film and place it on a clean, flat, stable surface.

UPS should be transported only in the original packaging to prevent damage to mechanical shocks and impacts.

2.1. Rack 19" Installation

UPS CORE series can be mounted in rack 19 ". UPS (2U) and battery module (2U) requires of space for installation. Each element requires optional mounting brackets (rack rails) for fixing the rack.

For proper installation of the following:

Step 1

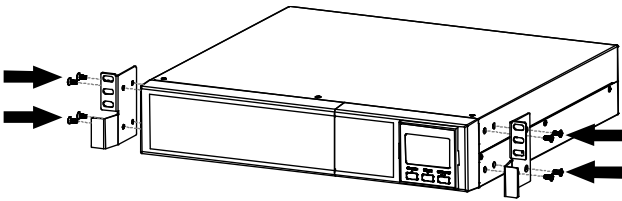

Step 2

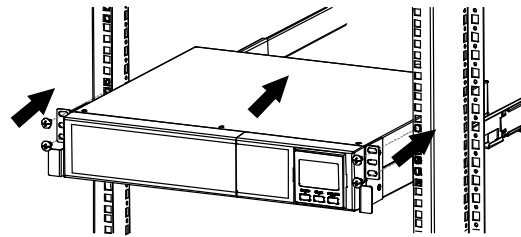

2.2. Tower Installation

To install the power supply in a Tower, use the special stands mounting adapter and allow its stable foundation in a vertical position.

For proper installation of the following:

Step 1

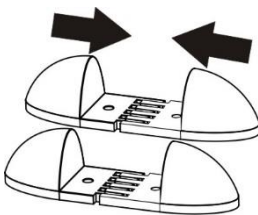

Step 2

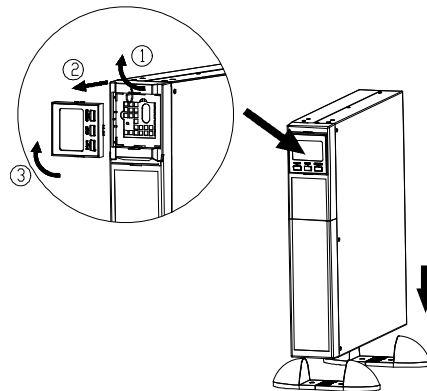

Step 3

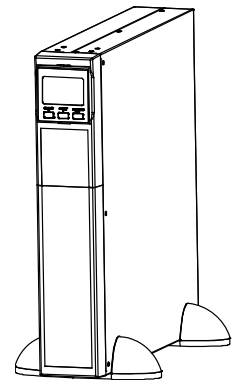

3. Design and connection

3.1. Rear panel view

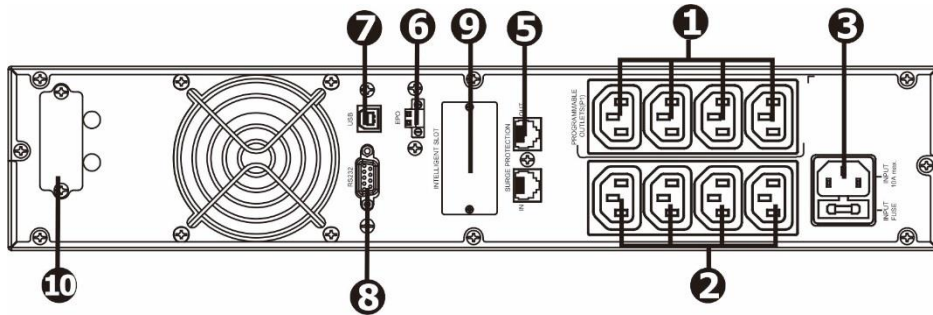

Draw. 1 UPS COVER CORE 1K

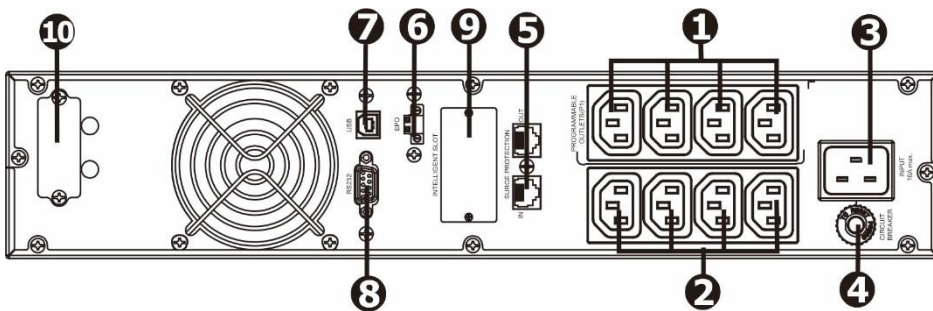

Draw. 2 UPS COVER CORE 2K

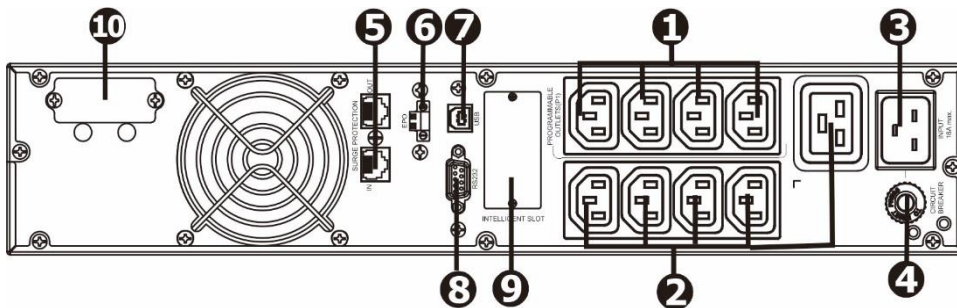

Draw. 3 UPS COVER CORE 3K

1. Programmable output sockets: can be switched off, suitable for less critical applications.
2. Critical output connections : to connect receivers critical. The voltage on these slots is non-stop as soon as the UPS is in normal mode or with a battery.
3. Supply socket.
4. Input fuse.
5. Surge protection TVSS (network, fax, modem).
6. Input of EPO.
7. Port USB.
8. Port RS-232.
9. Slot for communication card (SNMP).
10. Slot for external batteries (If UPS has external batteries).

3.2. Internal battery connection

In order to safely transport the UPS, the battery cables inside the UPS are disconnected. Before installing the UPS, follow the instructions below to connect the battery.

Step 1

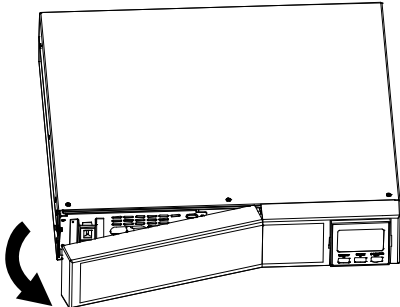

Remove the front panel.

Step 2

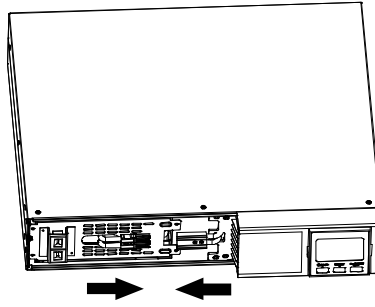

Connect the battery plugs.

Step 3

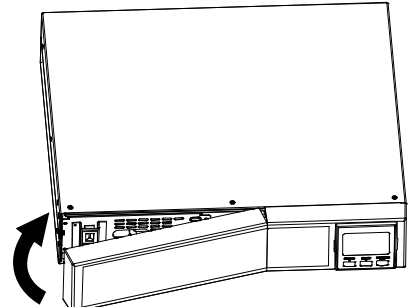

Mount the front panel.

3.3. Connecting external batteries

Connect one end of the battery cable to the appropriate socket on the UPS rear panel, the other end to the socket located on the battery module. For more battery modules, the remaining connections are made between the supplied battery modules as shown in the figure below.

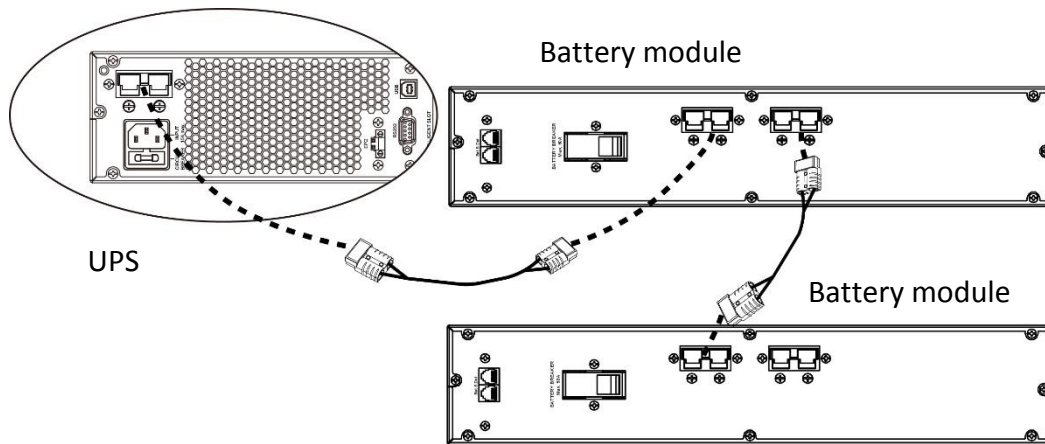

Warning! The maximum number of battery modules to connect is 4.

When attaching additional battery modules, the UPS must be checked and possibly adjusted for the connected capacity of the battery.

3.4. Power connection

Connect the power supply to an electrical outlet that is equipped with a protective conductor with a conductor supplied by the manufacturer. The power socket to which the power supply is connected should be protected with a surge suppressor. Recommended cross-section of the 2.5 mm² power cord. It is recommended to use a separate socket to power the UPS, protected by its own switch. The following is the current value for correct selection of UPS power protection.

UPS power	Minimum value of protection
1kVA	10A
2kVA	20A
3kVA	20A

3.5. Load connection

The UPS has been equipped with standard IEC 320 sockets. The IEC 320 C13 - C14 (10A) or IEC 320 C19-C20 (16A) cables are required to connect the receivers. 1 - 3kVA UPSs are equipped with 8 IEC 320 - C13 (10A) sockets. In addition, the 3kVA power supply unit has a 16A socket (IEC 320-C19).

The UPS has two groups of output sockets: programmable and fixed sockets. It is recommended to connect critical receivers to group 2 sockets, and smaller receivers to group 1 sockets.

In the event of a power failure, you can extend the operating time of critical receivers (connected to Group 2 sockets) on the battery by reducing the running time of devices connected to the programmable sockets (group 1). Programmable time for devices connected to the programmable sockets is available from the UPS configuration menu.

Do not connect the UPS output to devices that may cause overload, such as laser printers, electric stoves, heaters, etc.

The cables should be connected and placed in such a way that no one can accidentally disconnect them.

3.6. Connection of remote REPO switch

The UPS is equipped with an EPO port for the connection of the REPO remote switch (*Remote Emergency Power Off*).

The standard EPO port is configured as NC (normal close), EPO activation occurs by disconnecting the connection between pin 1 and pin 2 (removing the jumper). There is possibility to change EPO for NO (normal open) from Menu on LCD panel Changing the configuration to NO causes the jumper between pin 1 and pin 2 to be removed.

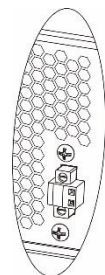

3.7. Connection of communication options

The UPS has three communication ports:

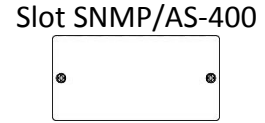

To enable automatic management and monitoring of the UPS, connect the UPS supplied with the UPS, from one side to the USB port on the UPS and the other to the USB port on the computer. Delivered with UPS software allows you to automate the on / off processes of the UPS connected to the UPS depending on the events that occur on the UPS (eg power outage, low battery, overload, etc.). The software also allows you to monitor your work and record UPS event history on-the-fly.

The UPS also has a slot for additional cards that allows you to retrofitting an SNMP network card for remote communication via the Internet or an AS-400 relay contact card for communication with external surveillance systems such as BMS.

Warning! RS-232 and USB ports can not be used simultaneously.

3.8. Connection of TVSS

In order to protect the data line (Internet / fax / telephone) from overvoltage, the UPS has an additional TVSS filter. Secure the unit to the sockets on the rear of the power supply unit as shown in the figure below.



4. Operation of the LCD display









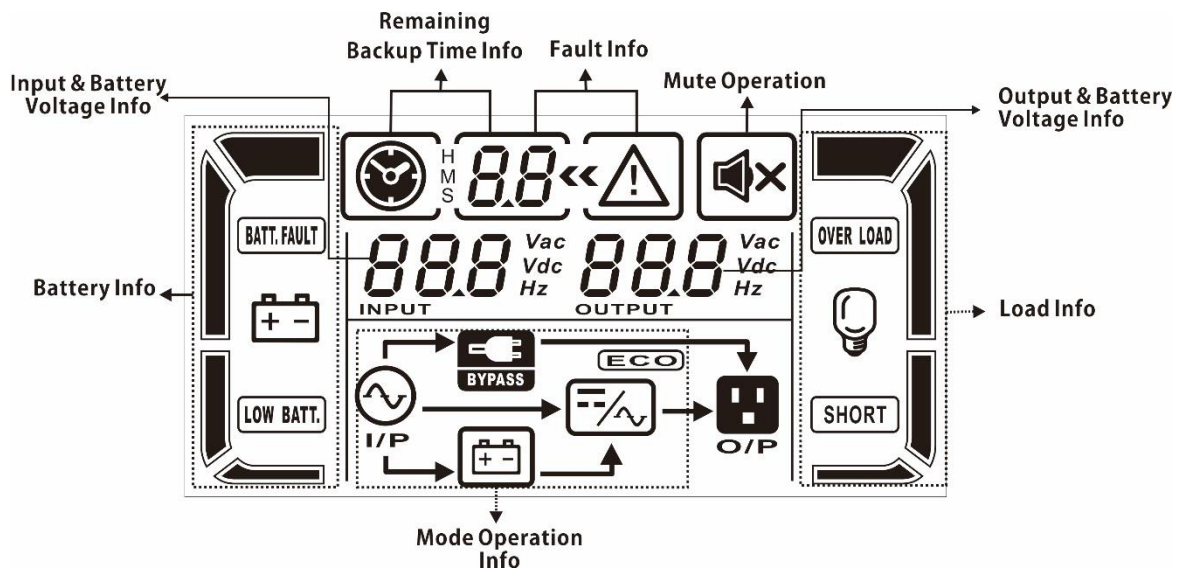









4.1. Function keys



Button	Function
ON/MUTE	<ul style="list-style-type: none"> UPS On: Press and hold for 2 seconds to turn on the UPS. Alarm mute: While operating the UPS from the battery, press and hold for 3 seconds to mute or turn on the beep. Alarm silencing is not possible in the event of an alarm condition. Up arrow: Scroll up to the previous line in the UPS settings menu. Turn on the auto test mode: Press and hold for 3 seconds during normal operation of the UPS to activate the test.
OFF/ENTER	<ul style="list-style-type: none"> UPS shutdown: Press and hold for 2 seconds to turn off the UPS. Confirm selection: Press the key to confirm the selection in the UPS settings menu.
SELECT	<ul style="list-style-type: none"> Switch between display information: Press to switch between information displayed on the panel like voltage, frequency, battery voltage. Setup Menu: Press and hold for 5 seconds to enter the UPS setup menu. This function is only available when the UPS is in bypass or stand-by mode. Down arrow: Scroll down to the next line in the UPS settings menu.

4.2. LCD panel



Display	Function
Information on time autonomy	
	Displays estimated autonomy time of the power supply H: hours, M: minutes, S: seconds
Configuration and error information	
	Displays the value of the parameter. A description of possible indications is contained in subsection 3.5.
	Displays an error or warning code. The error codes and warnings are described in subsections 3.7 and 3.8
Output information	
	Displays voltage or output parameters and battery voltage. Vac: output voltage, Hz: output frequency, Vdc: battery voltage
Display load information	
	Indicates load levels 0-24%, 25-49%, 50-74%, and 75-100%.
	Indicates the state of overload.
	Indicates short-circuit at the output of the device.
Information about the programmed outputs	
	Indicates whether the group of programmable sockets is configured.
Information on the operation	
	Indicates that the UPS is connected to a 230V network.
	Indicates that the UPS is running on battery.
	Indicates that the UPS is in Bypass mode.
	Indicates that the ECO mode is on.
	Indicates that the UPS inverter is working.
	Indicates that the output voltage is present.
	Indicates that the sound in the UPS is muted.
Battery information	
	Indicates the charge level of 0-24%, 25-49%, 50-74%, and 75-100%.
	Indicates that's battery is fail.
	Indicates low battery level.
Information about power and battery voltage	
	Displays voltage and input parameters and battery voltage. Vac: Input voltage 230V, Vdc: battery voltage, Hz: frequency

4.3. Sygnały alarmowe

Battery mode	Beep every 5 seconds.
Low battey	Beep every 2 seconds.
Overload	Beep every 1 second.
Fail	The signal is continuous.

4.4. Skróty literowe wyświetlacza LCD

Short	Display	Meaning
ENA	ENA	Enabled
DIS	DIS	Disabled
ESC	ESC	Escape
HLS	HLS	High loss
LLS	LLS	Low loss
BAT	BAT	Battery
BAH	BAH	Capacity Ah
CHA	CHA	Current of charger
CBV	CBV	Boost voltage
CFV	CFV	Float voltage
CF	CF	Converter
ON	ON	Turn on
EP	EP	EPO – emergency power off
AO	AO	EPO NC active
AC	AC	EPO NO active
TP	TP	Temperature
CH	CH	Charger
FU	FU	Unstable frequency of bypass
EE	EE	Error
FA	FA	Fan fail
BR	BR	Battery replacement

4.5. Menu UPS

Use of the UPS configuration menu is possible when the UPS is off (stand-by mode). To enter the configuration menu, press SELECT for 3 seconds as described in chapter 4.1. View configuration menu and description of setting options below.

Parameter 1



Indicates the number assigned to a particular parameter as described below, eg 01 - output voltage.

Parameters 2 and 3

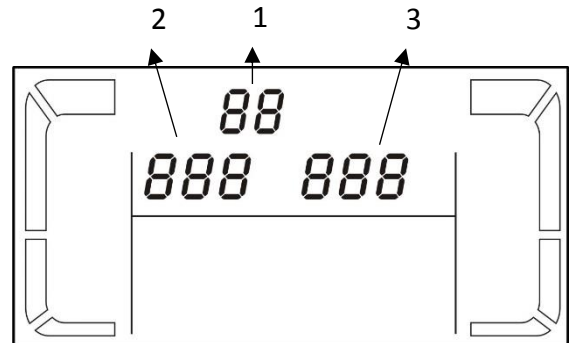
Indicates a value that is specific to the parameter, eg 230 - output voltage value.

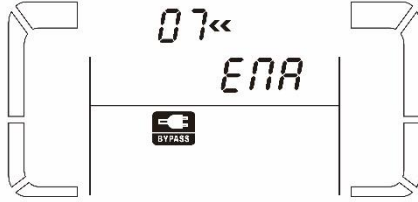

Display	Settings
01 - Setting the output voltage	
	200: Indicates the output voltage 200Vac 208: Indicates the output voltage 208Vac 220: Indicates the output voltage 220Vac 230: Indicates the output voltage 230Vac (default) 240: Indicates the output voltage 240Vac
02 – Frequency converter available / unavailable	
	ENA: Converter function available DIS: Converter function not available (default)
03 - Frequency setting	
	Frequency setting for battery operation: BAT 50: output frequency 50Hz BAT 60: output frequency 60Hz If the frequency converter function is available, you can select the output voltage frequency: CF 50: output frequency 50Hz CF 60: output frequency 60Hz
04 – ECO	
	Economic mode availability (ECO mode) ENA: ECO function available DIS: ECO function unavailable (default)
05 – AECO	
	Availability of advanced economic mode (AECO mode) ENA: AECO function available DIS: AECO function unavailable (default)

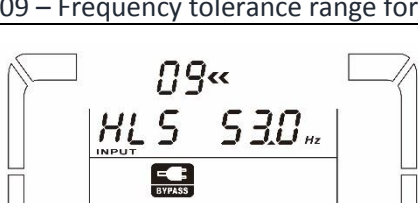
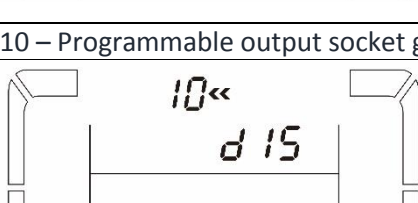
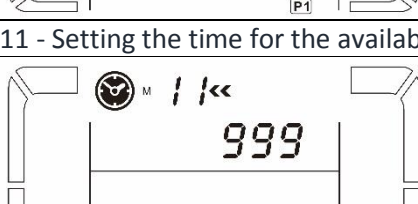
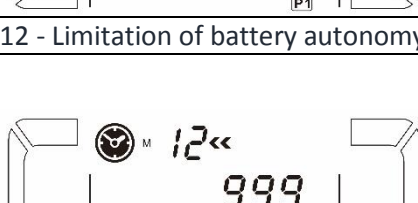
06 – Voltage tolerance range in ECO / AECO mode	
	<p>Setting the lower and upper power supply tolerances for ECO / AECO mode.</p> <p>HLS: Upper voltage supply voltage range. Use the arrow keys to select the range + 7V ÷ + 24V from the nominal value, eg 230V (default + 12V).</p> <p>LLS: Lower voltage range. Use the arrow keys to select the 77V ÷ -24V range from the nominal value, eg 230V (default -12V).</p>
07 – Bypass availability while the inverter is off	
	<p>Setting Bypass while UPS is off.</p> <p>ENA: Bypass available</p> <p>DIS: Bypass unavailable (default)</p>
08 – Voltage tolerance range for Bypass	
	<p>Setting the lower and upper power supply tolerances for Bypass. Exceeding the declared voltage thresholds causes the Bypass to be inaccessible.</p> <p>HLS: Upper voltage threshold Bypass. Use the arrow keys to select the voltage 230V ÷ 264V (default 264V).</p> <p>LLS: Lower threshold voltage Bypass. Use the arrow keys to select the voltage 170V ÷ 220V (default 170V).</p>
09 – Frequency tolerance range for Bypass	
	<p>Setting the lower and upper tolerances of the supply voltage for Bypass. Exceeding the declared frequency thresholds causes the Bypass track to be inaccessible.</p> <p>HLS: Upper Bypass frequency threshold. Use the arrow keys to select 51Hz to 55Hz (default 53Hz).</p> <p>LLS: Lower threshold Bypass frequency. Use the arrow keys to select 45Hz ÷ 49Hz (default 47Hz).</p>
10 – Programmable output socket group	
	<p>ENA: Slot function available (default)</p> <p>DIS: Slot function not available.</p>
11 - Setting the time for the availability of voltage on the programmable sockets	
	<p>Setting the timeout of devices connected to the sockets programmable from 0 to 999 minutes in battery mode. The time is counted from the time the UPS enters the battery mode.</p>
12 - Limitation of battery autonomy	
	<p>Parameter 2: Set the maximum battery operating time from 0 to 999 minutes for critical (unprogrammed) sockets.</p> <p>DIS: Lock restrictions. Autonomy depends on battery capacity. (Default)</p> <p>Warning! Set value "0" - means 10 seconds autonomy.</p>

13 - Setting the total battery capacity	
	Parameter 2: Setting the total capacity of installed batteries [Ah]. 7 - 999: Total battery capacity expressed in Ah. For external battery modules, enter the correct value.
14 - Charging current limitation (for additional charger versions)	
	Set maximum battery charging current 2/3/4 A: Maximum battery charging current.
15 - Setting the charging voltage in boost mode	
	Setting the charging voltage in boost mode. 225-240: Value of charging voltage x 0,01V / cell (default 236).
16 - Set the charging voltage in float mode	
	Setting the charging voltage in float mode. 220-233: Value of charging voltage x 0.01V / cell (default 228).
17 - EPO action logic setting	
	Setting EPO input logic. AO: Active opening - indicates the state of the EPO pins in the NC configuration (normally closed). Disconnected means EPO activation (default). AC: Active closed - indicates the status of the EPO pins in the NO (normally open) configuration. Closing the call means activating the EPO.
00 - Exit the settings menu	
	Exits the UPS configuration menu.

4.6. Description of UPS operating modes



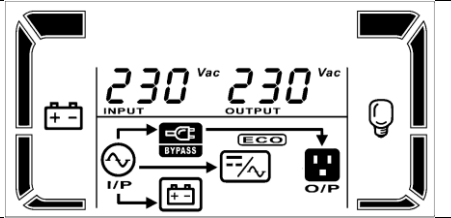
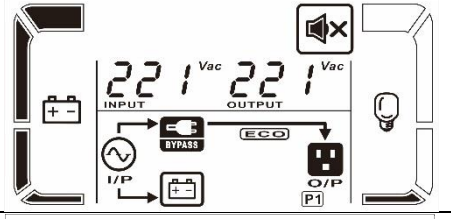
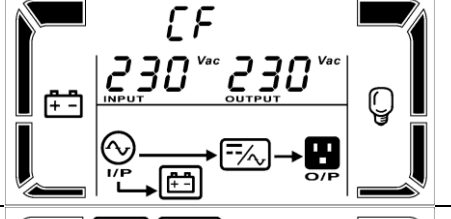
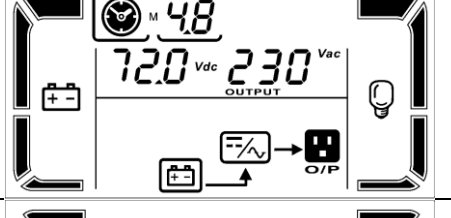
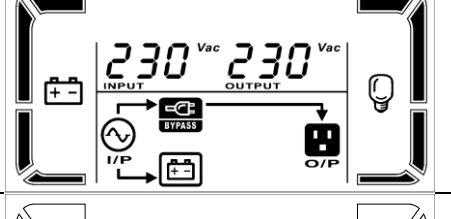
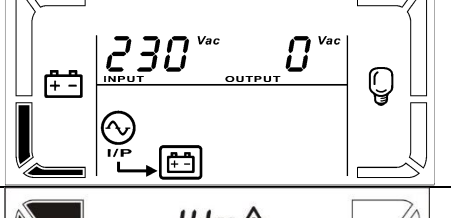
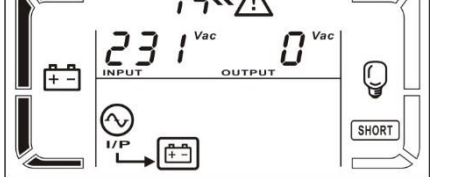







Mode	Description	Display
Normal mode (OnLine)	If the supply voltage is within tolerance, the UPS supplies the power directly from the professional network. In this mode, when the battery is fully charged, the fans are turned off to improve the performance of the unit.	

ECO mode	ECO mode If the supply voltage is within tolerances, the supply voltage is delivered directly to the UPS output. The inverter is in stand-by mode, resulting in increased efficiency and reduced operating costs.	
AECO mode	AECO mode If the supply voltage is within tolerances, the supply voltage is delivered directly to the UPS output. The inverter and rectifier in this mode are disabled.	
Converter mode	If the supply voltage is in the range of 40 ÷ 70Hz, it is possible to set the output frequency constant of 50 or 60Hz. In this mode also rechargeable batteries.	
Battery mode	In the event of a power failure or when the supply voltage is out of tolerance to maintain the output voltage within the required tolerance, the UPS will switch to battery operation. The sound signal is issued every 4 seconds	
Bypass mode	If the supply voltage is within tolerable tolerances but an overload or any other event occurs, the UPS switches to Bypass mode. The sound signal is issued every 10 seconds.	
Stand-by mode	UPS is off, no voltage is output. This mode is connected to an AC power source and the batteries are charged.	
Alarm	In emergency mode, the UPS indicates the error code and icons associated with the event.	

4.7. Error codes

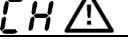
Error	Code	Icon	Error	Code	Icon
BUS start error	01	X	Short circuit inverter output	14	SHORT
BUS high voltage	02	X	Battery high voltage	27	BATT.FAULT
BUS low voltage	03	X	Battery low voltage	28	BATT.FAULT
Inverter error startup	11	X	High temperature	41	X
Inverter high voltage	12	X	Overload	43	OVER LOAD
Inverter low voltage	13	X	Charger fail	45	X

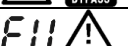
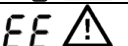
4.8. UPS warnings and sound alerts

Warning	Icon	Alarm
Battery low voltage		Beep every 2 seconds
Overload		Beep every second
Battery disconnected		Beep every second
Overload		Beep every 2 seconds
Wiring / connection error		Beep every 2 seconds
EPO active		Beep every 2 seconds
Overheated		Beep every 2 seconds
Charger fail		Beep every 2 seconds
Battery fail		Beep every 2 seconds (UPS is turn off)
Bypass out of tolerance		Beep every 2 seconds
Unstable bypass frequency		Beep every 2 seconds
EEPROM fail		Beep every 2 seconds
Fan fail		Beep every 2 seconds
Need to replace battery		Beep every 2 seconds

5. Operating the UPS

5.1. Turn on UPS

To turn on the UPS, press and hold the ON / Mute button on the UPS display for 2 seconds.

Warning! Charge the battery for at least 10 hours after first use for maximum autonomy. Maximum battery capacity is achieved after two full discharge / charge cycles.

5.2. Turn off UPS

To turn off the power supply, press and hold the OFF / ENTER button on the UPS display for 2 seconds. Depending on the setting of parameter 7 - bypass availability, the UPS disconnects the output or enters the electronic Bypass mode.

To completely switch off the UPS, unplug the power cord.

5.3. Battery test

In order to activate the test function, the ON / MUTE key must be pressed while holding the UPS in normal mode, economy or as a converter for 3 seconds. UPS automatically performs the test and then automatically goes to its previous operating state.

5.4. Mute the sound alarm

When the UPS is running on the battery, a beep sounds. To mute the UPS, press and hold the ON / MUTE button for 3 seconds.

5.5. Software installation

To fully utilize the UPS capability, you must install the supplied ViewPower communication software.

Follow the instructions that appear on the computer screen during installation. When the installation process is complete, restart the computer. Restarting your computer will automatically launch ViewPower, which is reflected in the ViewPower icon in the Windows system tray.

6. Operating environment and UPS operation

6.1. Working conditions

To ensure proper operating conditions for the guaranteed power supply system, the room where the power supply is located must be clean, free from dust and dirt.

Every few days (at least every 6 months or more, depending on the degree of soiling), the ventilation openings on the power supply should be cleaned to ensure free air flow. To prolong battery life, the ambient temperature should be between 15 and 25 ° C.

6.2. Storage conditions

If the UPS is not being used and is expected to be stored or stored, batteries must be recharged from time to time to avoid damaging them. Depending on the storage temperature, connect the power supply to the battery at least every 6 months.

Typically, the batteries are charged within 4h to 90% capacity, but it is recommended to leave the power supply on for 24-48 hours to fully charge the battery, which will extend the battery life.

Temp. Storage up to 20 ° C - charging every 6 months.

Temp. Storage up to 30 ° C - charging every 3 months.

Temp. Storage up to 40 ° C - charging every 1 month.

6.3. Battery replacement

If the UPS life is less than half the nominal battery life or UPS reports a battery alarm, replace the batteries immediately.

Warning! The UPS is equipped with internal batteries that can be exchanged during operation without switching off the power supply and connected receivers (hot swap function).

Although battery replacement is possible in Hot Swap mode, it is not recommended to replace the battery while the UPS and the receiver are operating. Any power failure may result in loss of data or damage to the receivers..

Replacing the battery according to the recommendations below is safe for the user. Only use batteries that are identical to the original capacities, voltages and dimensions.

When the batteries are disconnected, the receivers are not protected from power failure.

The battery must not be replaced when the UPS is in battery mode!

Step 1

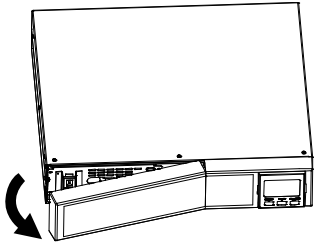

Remove the front panel.

Step 2

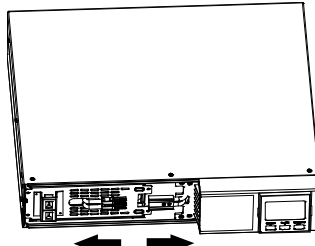

Disconnect the battery plugs.

Step 3

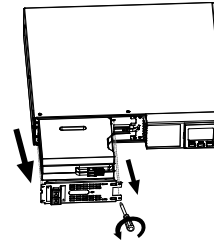

Remove the two retaining screws and pull out the battery pack.

Step 4

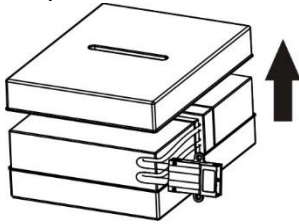

Remove the top cover from the battery pack and replace the batteries.

Step 5

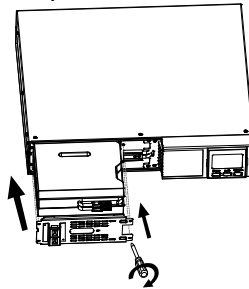

Replace the replaced battery pack and fix the retaining screws.

Step 6

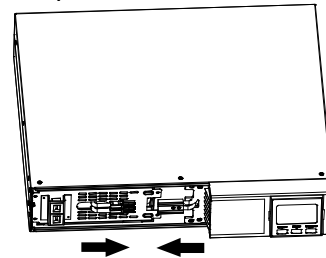

Connect the battery plugs.

Step 7

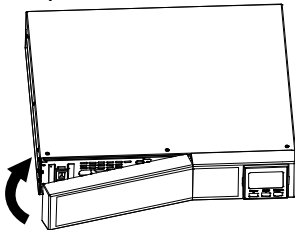

Mount the front panel.